

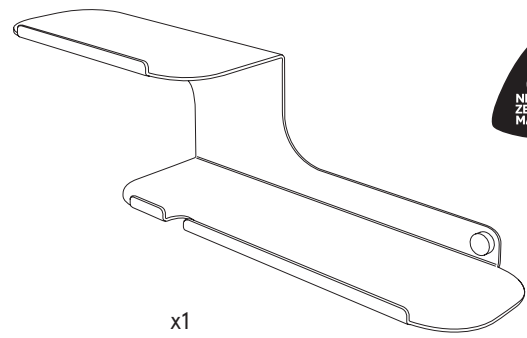



The Vanity



- 
A x2 Square-head screws
- 
B x2 Threaded sleeves
- 
C x2 End caps

INSTALLATION STEPS

1. Choose the location of The Vanity on the wall.

⚠ Make sure you have a solid fixing point at each screw connection. If you have no solid fixing where the screw connects to the wall, you will need a suitable wall anchor.

2. Hold The Vanity up to the desired position, and place a spirit level on top.
3. Using a pen/pencil mark on the wall through the centre of the two pre-drilled holes.
4. Take The Vanity off the wall.
5. Using a 3mm drill bit, drill into the marks you've made on the wall. If drilling through tiles, a 4.5mm bit will be required to pre-drill the depth of the tile.

⚠ ****FIXING TO WET AREA?** Fill pre-drilled holes with silicone/sealant before fixing The Vanity to the wall.

6. Hold The Vanity up to the wall so the holes line up.
7. Put the screw **A** through the threaded sleeve **B** and with a square-head screw driver, screw **A** into the wall, fixing The Vanity. Repeat this process with all two holes.
8. Finally hand screw on the end caps **C** onto the threaded sleeves **B**.

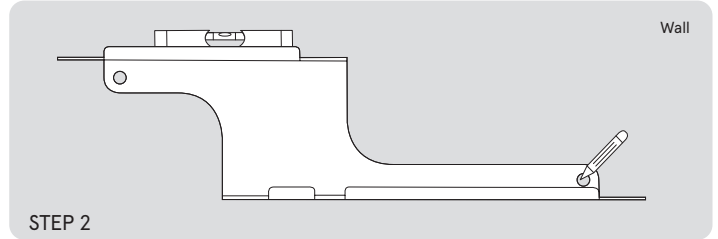

Front view

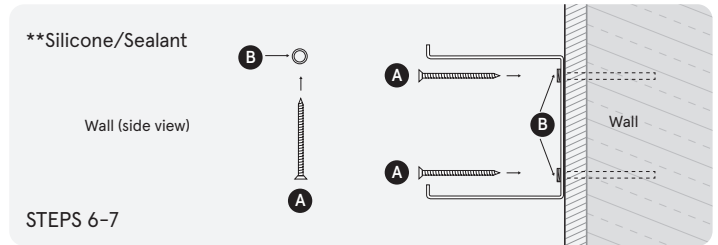



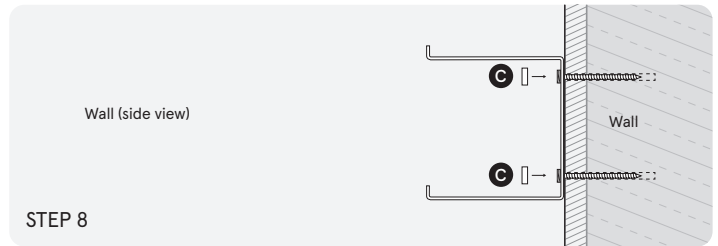

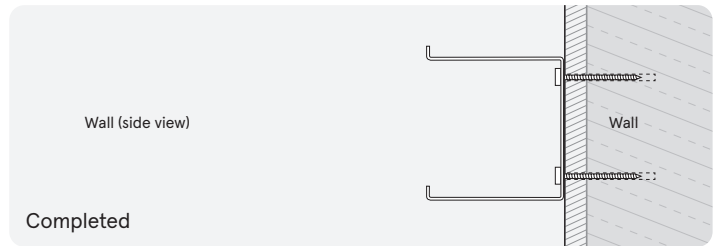

STEPS 6-7



STEP 8

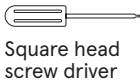

Completed

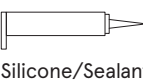
- | | | | |
|---|--|--|--|
|  Level |  Pencil / Pen |  4.5mm |  3mm |
|  Electric drill |  Square head screw driver |  Wall anchor* |  Silicone/Sealant** |

*Optional depending on wall and area.

For best installation results, we recommend using a qualified builder or professional installer.

CLEANING & CARE We recommend cleaning The Vanity weekly to stop soap scum build up.