

# The Roll

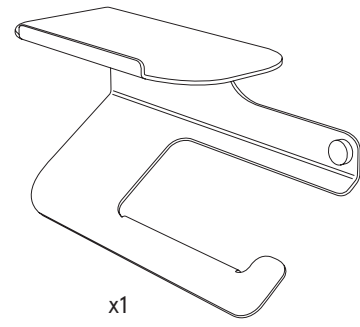
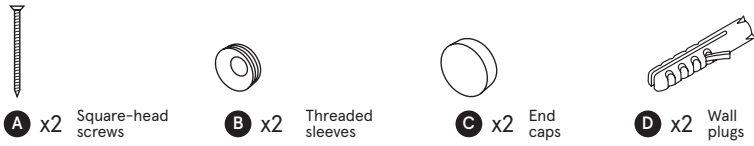

## INSTALLATION STEPS

1. Choose the location of The Roll in the corner.

⚠️ Make sure you have a solid fixing point at each screw connection. If you have no solid fixing where the screw connects to the wall, you will need to use the wall plugs provided.

2. Hold The Roll up to the desired position, tight in the corner and place a spirit level on top.
3. Using a pen/pencil mark on the wall through the centre of all two pre-drilled holes.

4. Take The Roll off the wall.

5. Using a 3mm drill bit, drill into the marks you've made on the wall. If drilling through tiles, a 4.5mm bit will be required to pre-drill the depth of the tile.

⚠️ **\*\*USING WALL PLUGS?** Drill into your 3mm holes with a 6mm drill bit, fit the wall plugs **D** inside and proceed.

⚠️ **\*\*FIXING TO WET AREA?** Fill pre-drilled holes with silicone/sealant before fixing The Roll to the wall.

6. Hold The Roll up to the wall so the holes line up.
7. Put the screw **A** through the threaded sleeve **B** and with a square-head screw driver, screw **A** into the wall, fixing The Roll. Repeat this process with the remaining hole.
8. Finally hand screw on the end caps **C** onto the threaded sleeves **B**.

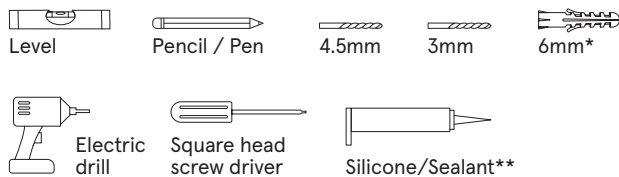
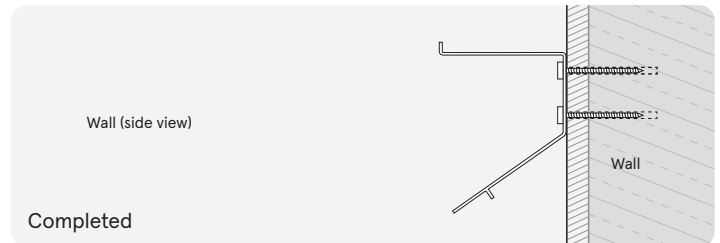
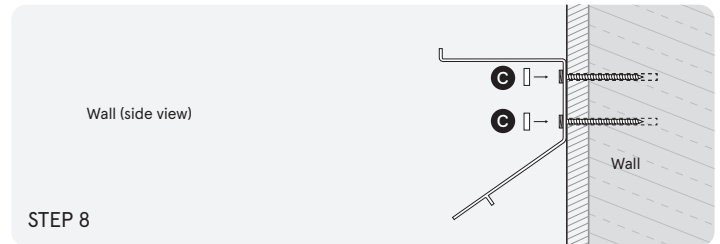
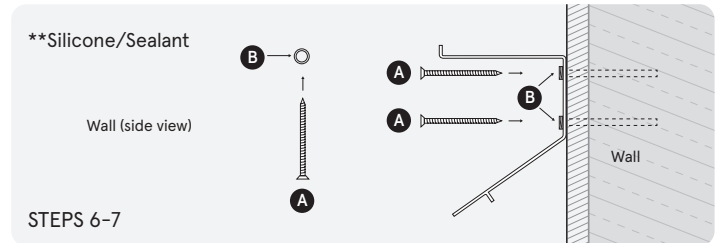
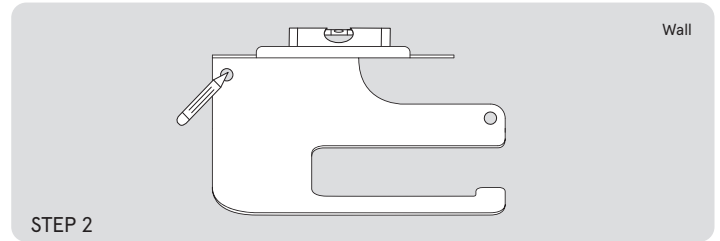

For best installation results, we recommend using a qualified builder or professional installer.

\*Optional depending on fixing point.